



MM-1

**Microphone Preamplifier
with Headphone Monitor**

User Guide and Technical Information

Sound Devices, LLC
E7556 State Rd. 23/33 • Reedsburg, WI • USA
+1 (608) 524-0625 • fax: +1 (608) 524-0655
Toll-Free: (800) 505-0625
www.sounddevices.com
support@sounddevices.com

General Description

Sound Devices MM-1 combines a high-performance microphone preamplifier with a flexible headphone monitor.

The full-featured, transformer-balanced microphone preamp produces low-noise, low-distortion gain at all switch positions. Its dual-stage limiter and high-pass filter prevent occasional signal extremes from overloading down-stream equipment.

The MM-1 is at home in a range of applications—film sound (boom operators), high-definition television production, corporate/industrial environments, radio/television announce booths, and music production. With its headphone monitoring function the MM-1 is a benefit in applications where communications channels and mix-minus feeds need to be monitored in headphones. The user can monitor both microphone audio and external audio sources in headphones with level control.

The MM-1 is designed for durability. Its extruded aluminum chassis, rugged end panels, machined knobs, and panel mounted connectors assure reliable mechanical operation.

Features

High Performance Microphone Preamplifier

- Maximum of 66 dB of gain, in eleven discrete steps for accurate, repeatable gain settings.
- Dynamic range exceeding 120 dB
- 10 Hz to 50 kHz audio bandwidth.
- High immunity to RF interference due to transformers, RF filtering, and all-metal construction
- High current line output driver capable of driving very long cable runs.
- Premium Lundahl input transformer with superior sonic quality and freedom from interference problems.
- Extended range peak limiter via dual opto-isolators makes preamplifier virtually “unclippable”.
- Selectable 48-volt / 12-volt phantom power or 12-volt T-power for condenser microphones.
- High-pass filter with two selectable corner frequencies, 80 and 160 Hz, 6 dB per octave.

Headphone Monitoring

- Headphone monitoring of microphone audio, external monitor audio, or a mix of both.
- Monitor input accepts balanced or unbalanced mono line-level inputs on 1/4-inch tip-ring-sleeve connector.
- Separate level control of Monitor gain and overall headphone gain.
- Split ear function via DIP switches.

Portable

- Internal battery power (two-AA) for convenient, low cost power.
- Excellent battery life with alkaline or lithium primary cells.
- External 5–17 VDC powering (plug included).

Durable Mechanical Construction

- High strength aluminum chassis withstands punishing field conditions.
- Panel-mounted connectors for strength and reliability.
- Easy access battery compartment for quick battery changes.
- Durable belt clip and end panels.

Specifications

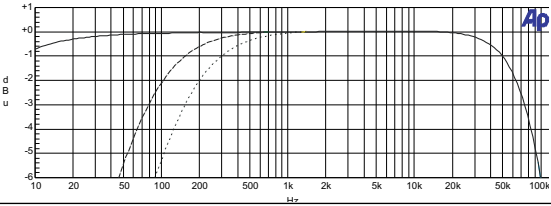
Gain: (Mic to Line)	0 dB to 66 dB input to output, switch selectable
Gain Accuracy (Mic - Line)	+0.6, -0.1 dB with reference to front panel gain markings (150 ohm source, 100k ohm impedances)
Frequency Response (Mic - Line)	20 Hz – 20 kHz, +0.1, -0.5 dB, -1 dB at 50 kHz (relative to 1 kHz level with 150 ohm source)  <p>MM-1 Frequency Response -- w/80 Hz HP .. w/160 Hz HP</p>
Equivalent Input Noise: (Mic)	-126 dBu (-128 dBV) maximum (150 ohm source, flat weighting, 22 Hz – 22 kHz bandwidth gain setting 36 dB or greater)
Output Clipping Level: (Line)	+22 dBu minimum with 100k ohm load +20 dBu minimum with 600 ohm load
Input Clipping Level: (Mic)	+4 dBu minimum at the 0 or +18 dB gain setting
Dynamic Range: (Mic to Line)	122 dB minimum at the +18 dB gain setting
THD + Noise:	.05% maximum (from 50 Hz – 22 kHz @ +4 dBu output level, 22 Hz – 22 kHz filter bandwidth, +46 dB gain setting)
Common Mode Rejection Ratio:	100 dB minimum at 80 Hz 60 dB minimum at 10 kHz
Input (Mic):	Transformer-balanced, 2k ohm input impedance
Input: (Monitor)	Electronically-balanced, 22k ohm input impedance
Output: (Line)	Transformer-balanced, 130 ohm output impedance
Headphone Output Impedance:	Unbalanced, 200 ohms
Frequency Response: (Monitor In)	10 Hz – 50 kHz, ±0.5 dB, gain at 50 %
Frequency Response (headphones):	10 Hz – 50 kHz, ±0.5 dB, gain at 50%
Input Clipping Level: (Monitor In)	Greater than +30 dBu
High-Pass Filter:	80 Hz or 160 Hz (switch selectable), 6 dB per octave
Phantom Power:	12 V or 48 V (switch selectable), will supply 10 mA per DIN 45 596 specification
T-Power:	12 V via 180 ohm resistors, will supply 10 mA
Limiter:	Limits to +17 dBu output level, 10:1 limiting ratio 5 ms attack time, 100 ms release time Amber/Red LED indicates limiting/clipping
Internal Voltage Rails:	±15 V, regulated
Power:	Internal: 2 x AA batteries External: 5–17 VDC via threaded coaxial jack, (5.5 mm outer diameter, 2.1 mm inner diameter), pin positive, sleeve negative. Voltages above 17 VDC cause no damage to unit but will open an internal poly fuse. Poly fuse will reset when voltage is removed.
Polarity:	All inputs to all outputs are non-inverting XLR – pin-2 = hot, pin-3 = cold, pin-1 is ground TRS – Tip = hot, ring = cold, sleeve = ground
Weight: (unit only)	0.64 kg, 1.42 lbs.
Dimensions: (unit only)	49 mm x 95 mm x 166 mm (h x w x d) (1.95" x 3.75" x 6.55")
Included Accessories:	Mating DC coaxial power connector, 4 rubber feet

Block Diagram

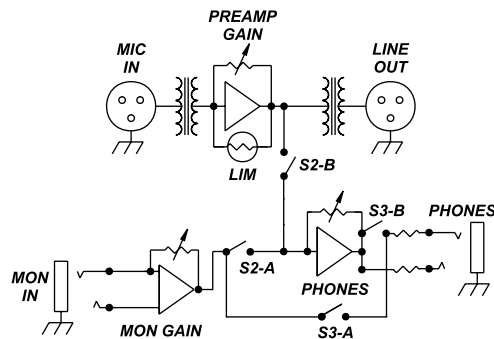

Front Panel Controls and Connectors

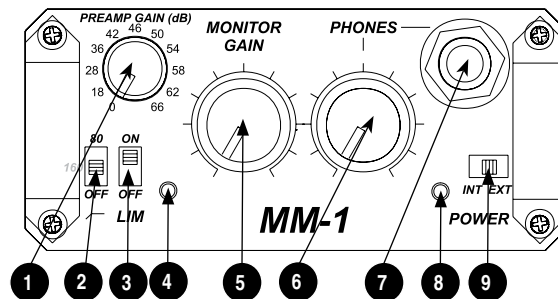

- 1) **Preamp Gain Switch (Rotary)**
Selects the amount of gain from input to output, adjustable in 11 increments.
- 2) **High-Pass Filter Switch**
Three-position switch inserts an 80 Hz or 160 Hz corner frequency filter, 6 dB per octave. Off position removes the filter from the signal path.
- 3) **Limiter Switch**
Activates the peak limiter. Limits to +17 dBu output.
- 4) **Limiter/Peak LED**
Bi-color LED illuminates red at 3 dB below clipping; illuminates amber to indicate limiter activity.
- 5) **Monitor In Gain**
Controls the level of Monitor Input signal.
- 6) **Phones Gain**
Controls the overall headphone monitor level of both preamp audio and monitor audio.
- 7) **Headphone Connector**
1/4-inch TRS mono headphone output; microphone audio and/or monitor audio in headphones.
- 8) **Power LED**
Bi-color LED illuminates green when the unit is powered and changes to red when approximately four hours of battery life remain.
- 9) **Power Switch**
Selects the power source for the unit, either Internal (battery) or External power.

Back Panel Controls and Connectors

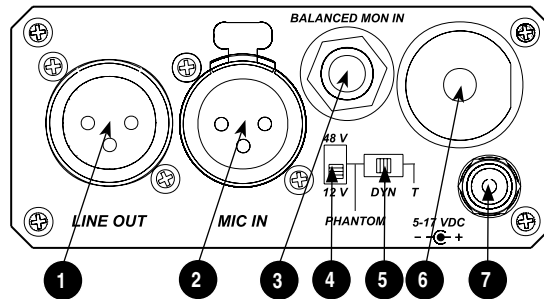

- 1) **Line Out**
Transformer-balanced line-level output. +22 dBu peak output level.
- 2) **Mic In**
Transformer-balanced XLR input accepts microphone level signals.
- 3) **Balanced Monitor Input**
Active-balanced ¼-inch connector accepts balanced or unbalanced line level signals from -10 dBu to +24 dBu.
- 4) **Phantom Voltage Switch**
Selects phantom voltages between 48 V or 12 V for mic powering.
- 5) **Microphone Power Switch**
Three-position switch selects Phantom power, T-power (12 Volts), or no power (DYN position).
WARNING: Do not use T-powering with phantom powered or dynamic microphones (see “Microphone Powering”).
- 6) **Battery Compartment**
Requires two AA batteries for operation. Insert positive (+) end of battery first
- 7) **External DC Input Connector**
Accepts 5–17 VDC, pin (+), sleeve (-).

Bottom Panel Switches

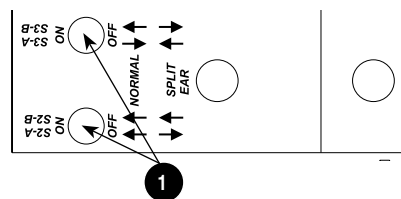

The bottom panel switches are accessible when the belt clip is removed. Use a 1/16-inch allen-head wrench.

- 1) **DIP Switches**
The “Split Ear” setting allows the a signal to be sent to the left headphone earpiece and a monitor signal to be sent to the right earpiece. Also, S2-B can mute the mic audio to the headphones.

Operational Notes

Transformers

The isolation characteristics of transformers are superior to any other balancing technique, particularly for the adverse and uncontrolled environments of field production. Transformers provide galvanic isolation from the driving source, meaning there is no direct electrical connection. Signals are “transformed” magnetically. Both transformers in the MM-1 use premium magnetic core material to achieve high signal handling capability (especially at low frequencies) while keeping distortion to a minimum. Because of their inherently high common mode impedance, transformers are unrivaled by any other type of input for common-mode noise rejection.

Both the microphone input and line output of the MM-1 can be balanced or unbalanced without problems. When unbalancing (either input or output) ground pin 3 to pin 1. There is no change in gain with an unbalanced connection into or out of the MM-1.

Microphone Powering

Microphones requiring phantom power should use the lowest voltage acceptable to maximize battery life. Most electret-condenser microphones can operate on phantom voltages from 11-52 volts. There is typically no performance benefit to using 48-volt; therefore 12-volt phantom is appropriate. Some microphones which require 48-volt phantom will not operate, or may operate with lower headroom and increased distortion at 12 volts; therefore use 48-volt phantom. Consult your microphone documentation for the appropriate voltage.

Dynamic microphones do not require phantom power. A properly connected balanced, dynamic microphone will not be affected by the presence of phantom power nor will it draw any current. However, it is good practice to turn phantom power off if the microphone cable is suspect. Poor or incorrectly wired microphone cable can cause audible artifacts in the microphone signal. (Phantom is an excellent cable tester.)

T-powering is a specific powering topology needed only for T-powered microphones. T-power electrically is 12 volts applied to pin 2 with respect to pin 3 of the XLR connector. Because of the voltage differential of T-power, it is incompatible with dynamic or phantom powered microphones and can permanently damage dynamic and phantom powered mics.

High-Pass Filter

The two positions of the high-pass filter (low-cut) in the MM-1 are useful for removing excess low frequency energy in the audio signals. The 80 Hz position is appropriate when recording general speech, music, and ambient sound. The 160 Hz position is useful to enhance speech clarity. The high pass filter is a single pole design, 6 dB per octave.

When possible, attempt to equalize at the sound source with microphone selection, use of a windscreen, microphone placement, and onboard microphone filtering. A high-pass filter on the microphone and a high-pass filter on the MM-1 will give an additive effect, increasing the slope of the filter.

Limiter

The MM-1 has a built-in peak responding limiter which can be turned on or off by the front panel switch. The MM-1 limiter is two separate limiters circuits activated by the one switch; the first limiter keeps the input gain stage from clipping, and the second limiter limits the output to +17 dBu. The two limiters enable the MM-1 to limit in excess of 50 dB, meaning that it is very difficult to clip the unit, no matter the gain setting. The Limiter LED on the front panel illuminates amber in proportion to the amount of limiting.

Headphone Monitoring

With headphones connected to the front panel headphone jack the MM-1 can be used to monitor either microphone audio, monitor audio, or a mix of both signals. The Phones level controls the overall headphone volume. The Monitor Gain adjusts the level of the monitor input signal.

The MM-1 is capable of driving headphones to dangerously high levels. Take precautions to prevent hearing damage.

Battery Life

Several factors affect battery life, including battery chemistry, ambient temperature of operation, microphone powering, and headphone drive levels. Experimentation is recommended to determine battery life for each individual setup.

Nickel-cadmium batteries are not recommended in the MM-1. These batteries have low energy per cell versus other types and provide very short operation.

Battery Type	Operational Characteristics	Battery Life
Duracell AA MN 1500	powered, idle	20 hrs.
Duracell AA MN 1500	dynamic microphone, +4 dBu output, 75 ohm headphones at moderate level	14 hrs.
Duracell AA MN 1500	condenser microphone (48V), 75 ohm headphones at high levels	8 hrs.
2000 mAh NiMH AA	dynamic microphone, +4 dBu output, 75 ohm headphones at moderate level	17 hrs.

(Test conditions: 70° F)

Application Notes

Line Driving/Mic Checking

Audio from remote microphones located more than 100 meters from a mixing console improve when sending line level signals to the mix position. Long cable runs at microphone level are more prone to noise and interference than line level signals. Phantom voltages can also drop over long cable runs—resulting in problems at the microphone. The MM-1 can be used to step microphone signals to line level, provide power to microphones, transformer-isolate grounds, and to verify microphone audio in headphones.

Wireless Boom Operator

The MM-1 can be used to allow a boom operator to have an un-tethered connection to a production van or mix position. The microphone is connected directly to the MM-1, and the “boom op” can hear microphone audio directly in headphones. The MM-1 is used to power the microphone and provide gain. The output of the MM-1 is connected to a body-pack wireless transmitter. A two-way radio’s earpiece output is connected to the monitor input of the MM-1. Via the two-way the boom operator receives director’s cues. The MM-1 allows the user to control monitoring levels of the comm feed and the microphone signal in headphones without affecting the microphone signal sent to the wireless transmitter.

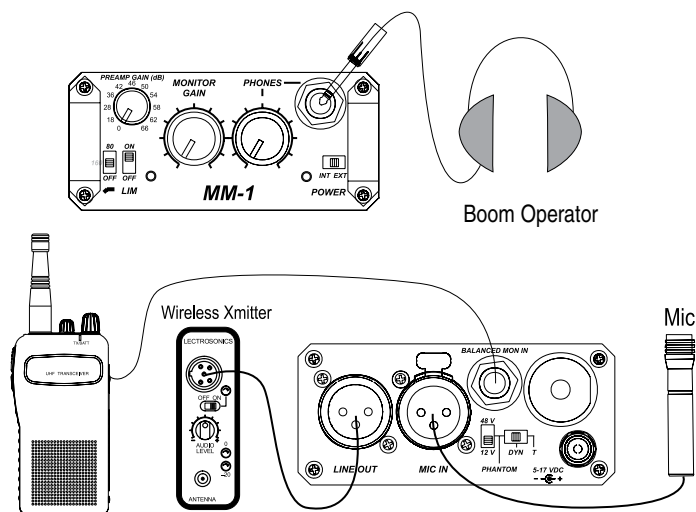

Radio/Television Announcer Position

The MM-1 is used as a microphone preamplifier for an announcer's microphone and can pass a mix-minus headphone feed to the announcer. Sending a line level signal from the announcer position to the main mixing console is preferred over sending a mic level signal. When engaged, the limiter prevents distortion during shouting and high microphone signal levels.

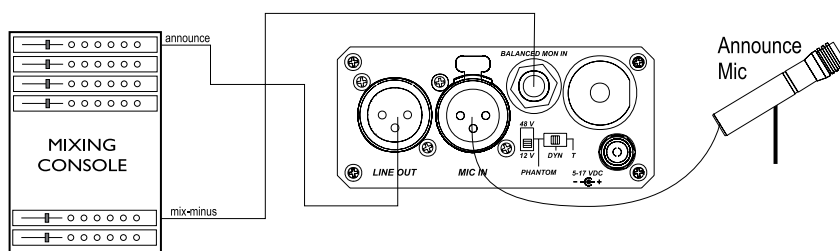
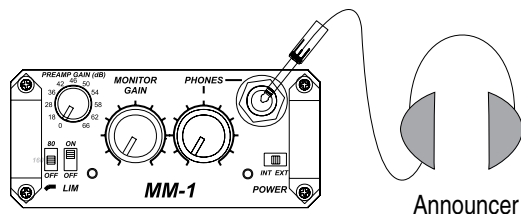

In the set-up above the announcer has level control in the headphones of their overall audio level and the level of the mix-minus feed.

Podium Microphones

Often podium microphones have long cable runs and “see” multiple audio consoles. Using an MM-1 between podium microphones and mixing consoles provides needed isolation for the microphone. Because the MM-1 has transformer coupling for both inputs and outputs the potential for ground loops is substantially reduced. Driving line level signals to mixing consoles and powering microphones locally greatly improves the reliability and audio quality of a podium mic feeds. The microphone is connected directly to the MM-1, which provides gain, microphone power, filtering, and limiting. In addition, the microphone signal can be verified using the headphone output of the MM-1.

CE Declaration of Conformity

According to ISO/IEC Guide 22

Sound Devices, LLC
E7556 State Rd. 23/33
Reedsburg, WI 53959 USA

declares that the product, MM-1 is in conformity with and passes:

EN55103-1, 1997	EMC-product family standard for audio, video, audio-visual and entertainment lighting control apparatus for professional use. Part 1: Emissions
EN55103-2, 1997	EMC-product family standard for audio, video, audio-visual and entertainment lighting control apparatus for professional use. Part 2: Immunity
EN55103-1 Phenomena 2, 3, 1997	Magnetic emissions at 1 meter 50 Hz – 50 kHz
EN55103-2 Phenomena 3, 1997	Magnetic immunity 50 Hz to 10 kHz
CISPR 22 (EN55022) 2003	Radiated and conducted emissions, Class B
EN61000-4-2 (2001)/ IEC61000-4-2 (2001)	ESD, ± 4 kV contact, ± 8 kV air discharge
EN61000-4-3 (2001)/ IEC1000-4-3 (2001)	Radiated RF immunity, 10 V/m, 80% 1 kHz amplitude modulation
EN61000-4-4 (2001)/ IEC61000-4-4 (2001)	AC power ports: EFT Burst, I/O lines, ± 0.25 kV to ± 1.0 kV, power line ± 0.5 kV – ± 1 kV
EN61000-4-4 (2001)/ IEC61000-4-4 (2001)	EFT Burst, I/O lines, ± 0.25 kV to ± 1.0 kV, power line ± 0.5 kV – ± 1 kV
EN61000-4-5 (2001)/ IEC61000-4-5 (2001)	Surge ± 1 kV differential mode (line-to-line), ± 2 kV common mode (line-to-ground)
EN61000-4-6 (2001)/ IEC61000-4-6 (2001)	Conducted RF immunity, 3 V, 80% @ 1 kHz amplitude modulation
EN61000-4-11 (2002)/ IEC61000-4-11(2001)	Voltage dips and short interruptions at test voltage level: 0% V unominal @ 70% V unominal @ 25 period

Tested by L. S. Compliance, Inc. Cedarburg, Wisconsin
February 15, 2003



Matthew Anderson
Director of Engineering
Sound Devices, LLC

FCC Statement

This device has been tested and found to comply with the limits for a class B digital device, pursuant to part 15 of the FCC rules. These limits are designed to provide reasonable protection against harmful interference in a residential installation. This equipment generates, uses, and can radiate radio frequency energy and, if not installed and used in accordance with the instructions, may cause harmful interference to radio communications. However, there is no guarantee that interference will not occur in a particular installation.

Limitation of Liability

LIMITATION ON SOUND DEVICES' LIABILITY. SOUND DEVICES, LLC SHALL NOT BE LIABLE TO THE PURCHASER OF THIS PRODUCT OR THIRD PARTIES FOR DAMAGES, LOSSES, COSTS, OR EXPENSES INCURRED BY PURCHASER OR THIRD PARTIES AS A RESULT OF: ACCIDENT, MISUSE, OR ABUSE OF THIS PRODUCT OR UNAUTHORIZED MODIFICATIONS, REPAIRS, OR ALTERATIONS TO THIS PRODUCT, OR FAILURE TO STRICTLY COMPLY WITH SOUND DEVICES, LLC'S OPERATING AND INSTALLATION INSTRUCTIONS. TO THE FULLEST EXTENT PERMITTED BY LAW, SOUND DEVICES SHALL HAVE NO LIABILITY TO THE END USER OR ANY OTHER PERSON FOR COSTS, EXPENSES, DIRECT DAMAGES, INCIDENTAL DAMAGES, PUNITIVE DAMAGES, SPECIAL DAMAGES, CONSEQUENTIAL DAMAGES OR OTHER DAMAGES OF ANY KIND OR NATURE WHATSOEVER ARISING OUT OF OR RELATING TO THE PRODUCTS, THESE TERMS AND CONDITIONS OR THE PARTIES' RELATIONSHIP, INCLUDING, WITHOUT LIMITATION, DAMAGES RESULTING FROM OR RELATED TO THE DELETION OR OTHER LOSS OF AUDIO OR VIDEO RECORDINGS OR DATA, REDUCED OR DIMINISHED AUDIO OR VIDEO QUALITY OR OTHER SIMILAR AUDIO OR VIDEO DEFECTS ARISING FROM, RELATED TO OR OTHERWISE ATTRIBUTABLE TO THE PRODUCTS OR THE END USER'S USE OR OPERATION THEREOF, REGARDLESS OF WHETHER SUCH DAMAGES ARE CLAIMED UNDER CONTRACT, TORT OR ANY OTHER THEORY. "CONSEQUENTIAL DAMAGES" FOR WHICH SOUND DEVICES SHALL NOT BE LIABLE SHALL INCLUDE, WITHOUT LIMITATION, LOST PROFITS, PENALTIES, DELAY DAMAGES, LIQUIDATED DAMAGES AND OTHER DAMAGES AND LIABILITIES WHICH END USER SHALL BE OBLIGATED TO PAY OR WHICH END USER OR ANY OTHER PARTY MAY INCUR RELATED TO OR ARISING OUT OF ITS CONTRACTS WITH ITS CUSTOMERS OR OTHER THIRD PARTIES. NOTWITHSTANDING AND WITHOUT LIMITING THE FOREGOING, IN NO EVENT SHALL SOUND DEVICES BE LIABLE FOR ANY AMOUNT OF DAMAGES IN EXCESS OF AMOUNTS PAID BY THE END USER FOR THE PRODUCTS AS TO WHICH ANY LIABILITY HAS BEEN DETERMINED TO EXIST. SOUND DEVICES AND END USER EXPRESSLY AGREE THAT THE PRICE FOR THE PRODUCTS WAS DETERMINED IN CONSIDERATION OF THE LIMITATION ON LIABILITY AND DAMAGES SET FORTH HEREIN AND SUCH LIMITATION HAS BEEN SPECIFICALLY BARGAINED FOR AND CONSTITUTES AN AGREED ALLOCATION OF RISK WHICH SHALL SURVIVE THE DETERMINATION OF ANY COURT OF COMPETENT JURISDICTION THAT ANY REMEDY HEREIN FAILS OF ITS ESSENTIAL PURPOSE.

Warranty

Sound Devices, LLC warrants the MM-1 Microphone Preamp with Headphone Monitoring against defects in materials and workmanship for a period of ONE (1) year from date of original retail purchase. This is a non-transferable warranty that extends only to the original purchaser. Sound Devices, LLC will repair or replace the product at its discretion at no charge. Warranty claims due to severe service conditions will be addressed on an individual basis. THE WARRANTY AND REMEDIES SET FORTH ABOVE ARE EXCLUSIVE. SOUND DEVICES, LLC DISCLAIMS ALL OTHER WARRANTIES, EXPRESS OR IMPLIED, INCLUDING WARRANTIES OF MERCHANTABILITY AND FITNESS FOR A PARTICULAR PURPOSE. SOUND DEVICES, LLC IS NOT RESPONSIBLE FOR SPECIAL, INCIDENTAL, OR CONSEQUENTIAL DAMAGES ARISING FROM ANY BREACH OF WARRANTY OR UNDER ANY OTHER LEGAL THEORY. Because some jurisdictions do not permit the exclusion or limitations set forth above, they may not apply in all cases.

For all service, including warranty repair, please contact Sound Devices for a return authorization number (RMA) before sending the unit for service. Service returns should be sent to:

Sound Devices, LLC
Service Repair (RMA # XXXX)
E7556 State Rd. 23/33
Reedsburg, WI 53959 USA
telephone: (608) 524-0625

SOUND **DEVICES**